



## VK-1316S/12V

Article-No.: 91931

1/3" Camera, B&W, 570TVL,  
12VDC

### Mainfeatures

Resolution of 570 horizontal lines  
Automatic gain control (AGC)  
Aperture control (APC)  
Internal synchronization  
C/CS mount

High sensitivity  
Automatic shutter control (AES)  
Backlight compensation (BLC)  
Auto iris and DC iris control  
Supply voltage: 12VDC



### Specifications

System	black&white
Video standard	CCIR
Sensor size	1/3"
Imager	CCD
Imager	Sony Super HAD Interline Transfer
Active picture elements	440,000, (H) 752 x (V) 582
Horizontal resolution	570 TVL
Synchronization	internal
Signal-to-noise ratio	46db (AGC OFF)
Gamma correction	0.45
Sensitivity (at 50% video signal)	0,1 Lux
Sensitivity (at 50% video signal)	at F1.2 (measured)
Automatic electronic shutter (ESC)	yes
Low speed shutter	no
Digital Noise Reduction (DNR)	no
Backlight compensation	BLC
Wide Dynamic Range (WDR)	no





## Specifications (continued)

Aperture Correction (APC)	horizontal and vertical
IR cut filter	no
Activity detection	no
Digital zoom	no
e-PTZ support	no
Lens mount	CS mount
Iris control	Manual iris, Auto-Iris/DC controlled iris
Illumination	no
External adjustments	Shutter ON/OFF, AGC ON/OFF, AI/DC iris control, Flange focus Level for DC controlled lenses
Video outputs	composite (VBS)
Video outputs	1Vp-p, VBS, 75Ohm
External connections	Video (BNC), Auto Iris/DC iris (4 pin), Power input (2 pin)
Serial interfaces	no
Camera mount	1/4" - 20 UNC thread on top and bottom
Alarm inputs	-
Alarm outputs	-
Supply voltage	12VDC
Supply voltage	(+/-20%)
Power consumption	4W
Housing	indoor
Colour	Pantone 877, Front and back: Pantone 8400C
Hidden cable management	no
Vandalism resistant	no
Protection rating	n/a
Temperature range (operation)	-10°C ~ +50°C
Dimensions (HxWxD)	see drawing
Weight	225g
Parts supplied	Camera, C/CS Mount ring, 4-pin lens plug, Manual
Certificates	CE

## Optional Accessories

Image	Artikel-Nr. / Typ	Description
	VT-PS12DCDT1	PSU 12VDC/1.0A, Regulated, Desktop Version, 1.8m Cables each w. open ends
	WD-23	Wall Mount Bracket with Ball Joint, 1/4" Camera Fixing Screw, Pantone 877

## Optional Accessories (continued)

Image	Artikel-Nr. / Typ	Description
	WD-22	Wall Mount Bracket with Ball Joint, 1/4" Camera Fixing Screw, Beige Grey
	WD-18	Wall Mount with Ball Joint, 1/4" Camera Fixing Screw, beige Grey
	VT-PS12DC-7	Plugable PSU w. Cont. & UK Mains plug-in 100-240VAC/12VDC-1.25A, Regulated
	VT-PS12DC-9	Plug-in Power Supply Unit 100-240VAC 12VDC (1.0Amp), Regulated, w. open Ends

## Technical Drawing

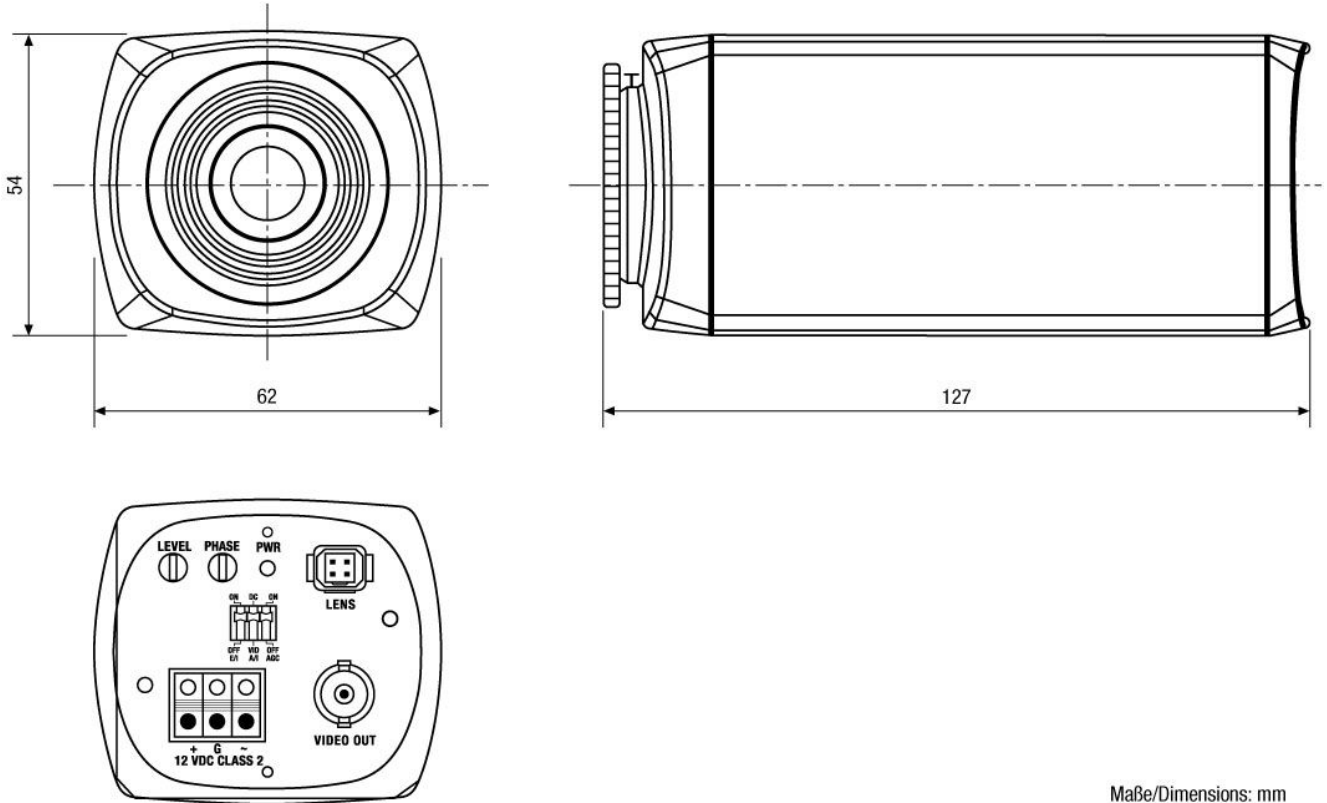

Maße/Dimensions: mm

Your partner for eneo products:

