



VKC-1417/IR

Article-No.: 91986

1/4" Day&Night Camera, IR
Illumination, F1.6/3.5-91mm,
26x Zoom, 480TVL, 12VDC

Mainfeatures

Integrated 26x AF Zoom Lens/10x Digital Zoom
Sensitivity of 0.78Lux at F1.2 (Colour)
Digital Signal Processing (DSP)
Electronic Shutter Control (ESC)
Automatic White Balance (AWB)
RS-485 Serial Control Interface

Resolution of 480 Horizontal Lines
On-screen Menu Control
Programmable Back Light Compensation (BLC)
H/V Aperture Correction (APC)
IR Illumination by 7 integral 850nm LEDs
Supply Voltage: 12VDC

Specifications

System	day&night
Video standard	CCIR/PAL
Sensor size	1/4"
Imager	CCD
Imager	1/4" Sony Super HAD Interline Transfer CCD
Active picture elements	440,000, 752(H) x 582(V)
Synchronization	internal
Signal-to-noise ratio	48dB
Horizontal resolution	480 TVL
Sensitivity (at 50% video signal)	0.78Lux (colour); 0.53Lux (B&W), Videor measurement result at F1.2
Automatic electronic shutter (ESC)	1/50 - 1/10,000sec., automatic and manual
Low speed shutter	no
Automatic gain control (AGC)	manual adjustable (via menu control)
Digital Noise Reduction (DNR)	no
White balance	automatic (AWB) selectable for indoor and outdoor or manual





Specifications (continued)

Backlight compensation	BLC
Backlight compensation	manual and automatic, ON/OFF switchable
Wide Dynamic Range (WDR)	no
IR cut filter	switchable
Video outputs	composite (CVBS)
Lens type	zoom
Lens	F1.6/F3.8 - 70/3.5 - 91mm (26x Zoom)
Focal length	3,5 mm - 91 mm
Digital zoom	2x - 10x
Horizontal angle of view	55° - 2,2°
Iris control	DC
Focus control	automatic and manual
MOD (Minimum object distance)	0,1-1 m
MOD (Minimum Object Distance)	Wide angle: 10cm Tele end: 1.0m
Illumination	infrared
Illumination	7x LED's 850nm at 30° hor. illumination angle. Due to an integrated light sensor the LED illumination will be switched ON/OFF, depending on environmental illumination conditions approx. 5m (at a good light reflexion and 40% Videosignal)
Illumination range	
Menu languages	English and Korean
OSD function control	Main menu: Camera-ID no., Language selection, Camera titel/text, Colour/B&W switching, Sharpness, Hor. mirror function, Positive/Negative switching. Focus: Mode, Autofocus, Object distance, Zoom end positions/speed. AWB: White balance indoor/outdoor, Red/Blue contrast, Automatic control. AE: Mode, Brightness, Flickerless, Shutter, Iris, AGC control. Day&Night: Mode (Automatic, Day or Night), IR Filter (Brightness level/Delay), IR LED ON/OFF. BLC: Automatic or manual. Motion: Mode, Detecting area, Sensitivity, Alarm display/output via RS-485. Display: Menu ON/OFF, Function display. Initial: Camera settings ON/OFF
Menu driven set-up	ON/OFF switchable
Text display	10 digit
Serial interfaces	RS-485
Serial port	RS-485 (Pelco D protocol)
External adjustments	Menu: ON/OFF, Focus: Near/Far, Zoom: T/W
External connections	Video (BNC), 12VDC Power input, 6 pin RS-485 Serial interface socket
Temperature range (operation)	-10°C ~ +50°C
Housing material	plastic
Housing	indoor
Integrated wall mount	no
Hidden cable management	no



Specifications (continued)

Sunshield	no
Window heater	no
Colour (housing)	silver grey
Protection rating	IP40
Supply voltage	12VDC
Power consumption	4.2W max.
Dimensions (HxWxD)	see drawing
Weight	approx. 300g
Parts supplied	Camera, Manual
Certificates	CE

Optional Accessories

Image	Artikel-Nr. / Typ	Description
	WD-23	Wall Mount Bracket with Ball Joint, 1/4" Camera Fixing Screw, Pantone 877
	WD-21/RAL9006	Wall Mount Bracket with Ball Joint, 1/4" Camera Fixing Screw, RAL9006
	WD-18	Wall Mount with Ball Joint, 1/4" Camera Fixing Screw, beige Grey
	VT-PS12DCDT1	PSU 12VDC/1.0A, Regulated, Desktop Version, 1.8m Cables each w. open ends
	KBD300A	System Keyboard with Joystick for Pelco Matrix Switchers CM6700/6800 and Esprit

Optional Accessories (continued)

Image	Artikel-Nr. / Typ	Description
	KBD200A	System Keyboard for Pelco Matrix Switchers CM6700/6800 and Esprit Systems
	VT-PS12DC-7	Plugable PSU w. Cont. & UK Mains plug-in 100-240VAC/12VDC-1.25A, Regulated
	VT-PS12DC-9	Plug-in Power Supply Unit 100-240VAC 12VDC (1.0Amp), Regulated, w. open Ends

Technical Drawing

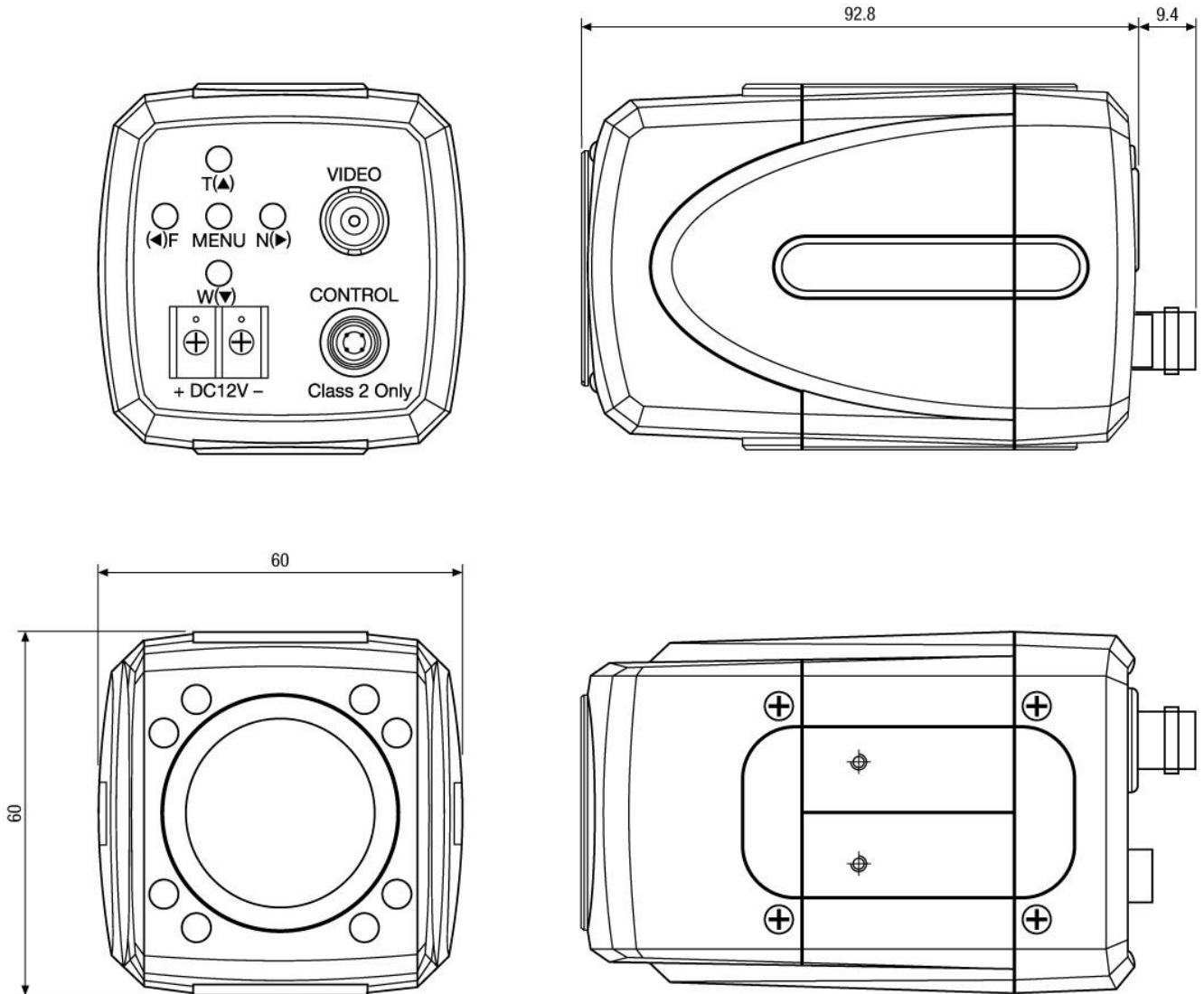

Maße/Dimensions: mm



Your partner for eneo products:

