



VKC-1345/12V

Article-No.: 92062

1/3" Colour Camera with DSP,
AGC, APC BLC, ESC, AWB, 12VDC,
550TVL

Mainfeatures

Resolution of 550 Horizontal Lines
High Sensitivity of 0.34Lux at F1.2
Electronic Shutter Control (ESC)
Flickerless Function

Automatic Gain Control (AGC)
Back Light Compensation (BLC)
AI/DC Iris Lens Control
Automatic White Balance (AWB)





Specifications

System	colour
Video standard	CCIR/PAL
Sensor size	1/3"
Imager	CCD
Imager	Sony Super HAD Interline Transfer
Active picture elements	440,000, 752(H) x 582(V)
Horizontal resolution	550 TVL
Horizontal resolution	colour (VT measurement result)
Synchronization	internal
Signal-to-noise ratio	48dB
Sensitivity (at 50% video signal)	0,34 Lux
Sensitivity (at 50% video signal)	at F1.2 (measured)
Automatic electronic shutter (ESC)	1/50 - 1/100,000sec.
Low speed shutter	no
Digital Noise Reduction (DNR)	no
Backlight compensation	BLC
Backlight compensation	ON/OFF switchable
Wide Dynamic Range (WDR)	no



Specifications (continued)

White balance	automatic
Flickerless function	ON/OFF switchable
Lens mount	CS mount
Iris control	Manual iris, DC/Al controlled iris
External adjustments	ELC (manual Iris) / DC (DC Iris control) / Video (Auto Iris control) switch
Video outputs	composite (CVBS)
Video outputs	1Vp-p, CVBS, 75ohms, BNC
External connections	Video (BNC), Voltage input
Serial interfaces	no
Camera mount	1/4" - 20 UNC thread on top and bottom
Supply voltage	12VDC
Supply voltage	(10 ~15V), 12VDC ±0,5V recommended
Power consumption	2.4W
Colour	silver grey
Temperature range (operation)	-10°C ~ +50°C
Weight	approx. 315g
Parts supplied	Camera, C/CS Mount ring, 4-pin lens plug, Manual
Certificates	CE

Optional Accessories

Image	Artikel-Nr. / Typ	Description
	WD-21/RAL9006	Wall Mount Bracket with Ball Joint, 1/4" Camera Fixing Screw, RAL9006
	WD-22	Wall Mount Bracket with Ball Joint, 1/4" Camera Fixing Screw, Beige Grey
	WD-23	Wall Mount Bracket with Ball Joint, 1/4" Camera Fixing Screw, Pantone 877
	VT-PS12DCDT1	PSU 12VDC/1.0A, Regulated, Desktop Version, 1.8m Cables each w. open ends

Optional Accessories (continued)

Image	Artikel-Nr. / Typ	Description
	VT-PS12DC-7	Plugable PSU w. Cont. & UK Mains plug-in 100-240VAC/12VDC-1.25A, Regulated
	VT-PS12DC-9	Plug-in Power Supply Unit 100-240VAC 12VDC (1.0Amp), Regulated, w. open Ends

Technical Drawing

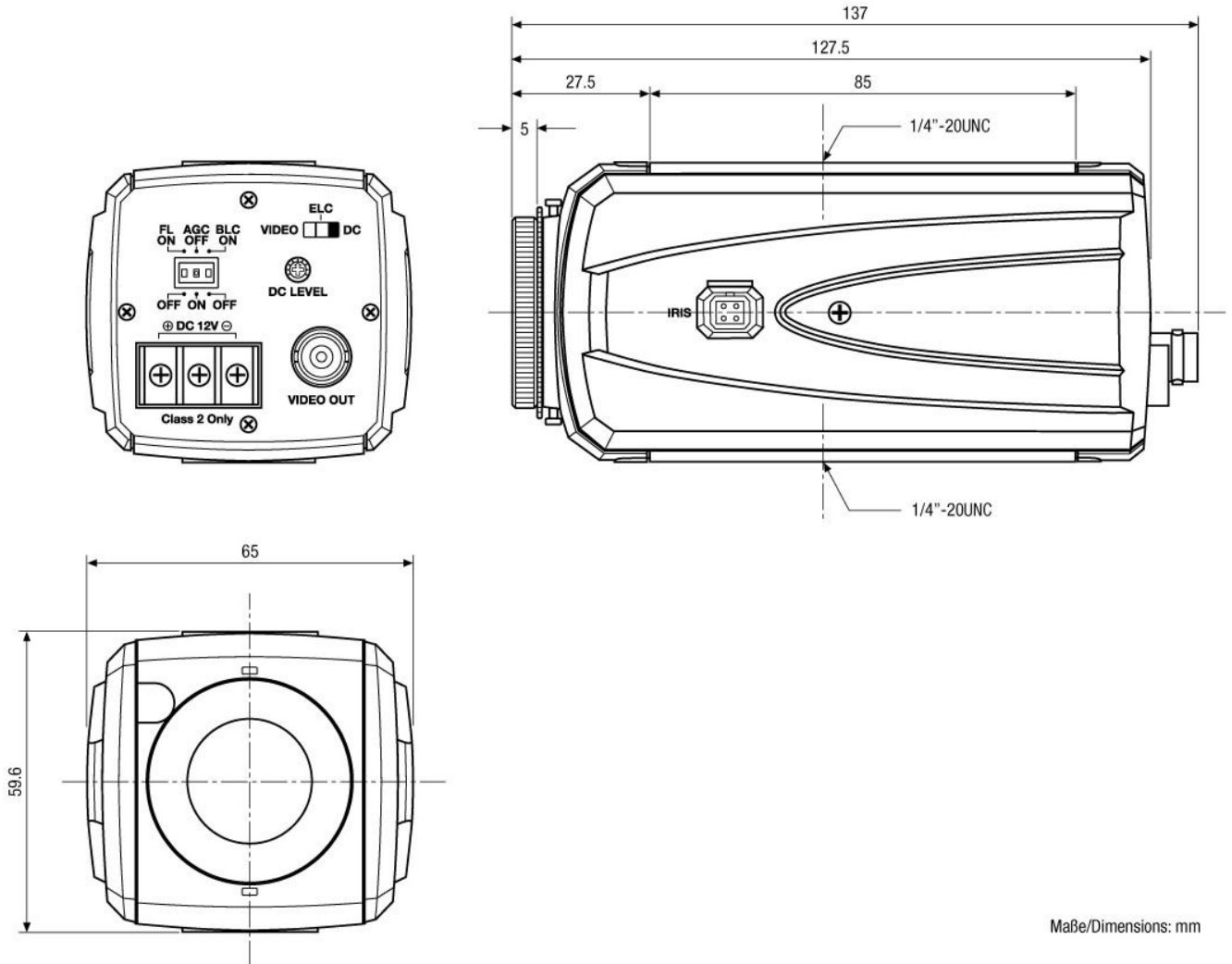

Maße/Dimensions: mm

Your partner for eneo products:

