



GLC-1602H

Article-No.: 92515

1/3" Network Camera, Colour,
H.264, MJPEG, 704x576, 12VDC

Mainfeatures

High Resolution Network Camera (Super HAD CCD)
Simultaneous Video Streaming (H.264 & MJPEG)
E-Mail and FTP Transmission of Important Events
Ethernet Interface: 10/100Base-TX
Alarm In/Output, Audio Output

Horizontal Resolution of 520 TV Lines (colour)
Simultaneous Video and Audio Signal Transmission
Integrated Activity Detection
Supports Various Network Environments
Upgrade via SD Card, USB Interface and Network

Specifications

Series	eneo GL
Resolution standard	SD
System	colour
Video standard	PAL
Sensor size	1/3"
Imager	CCD
Imager	Sony Super HAD Interline Transfer CCD (with HQ1 DSP)
Sensitivity (at 50% video signal)	1,2 Lux
Sensitivity (at 50% video signal)	at F1.2 (measured)
Horizontal resolution	520 TVL
Automatic gain control (AGC)	8/12/24/30dB, selectable
Automatic electronic shutter (ESC)	1/50 - 1/100,000sec.
Digital Noise Reduction (DNR)	no
Low speed shutter	no
White balance	2500 - 9500K
Wide Dynamic Range (WDR)	no
Backlight compensation	BLC

Specifications (continued)

IR cut filter	standard
Privacy zones masking	3 areas
Activity detection	yes
Motion detector	96 areas, 5 levels
Text display	supplied
Picture adjustments	Max. AGC gain, Contrast, Brightness, BLC, Sharpness, Colour saturation and Fluorescent light
External connections	Video (BNC), Audio, USB1.1, Network (RJ-45), Alarm Input/Output, Reset, Power Input, RS-232, RS-485, DC-Lens composite (CVBS)
Video outputs	1Vp-p, (C)VBS, 75ohms, BNC
Video outputs	M-JPEG watermark
Digital signature	yes
Audio support	built-in microphone, 16Bit, 8kHz
Audio	1
Alarm inputs	1 (software supported)
Alarm inputs	1
Alarm outputs	1
Alarm handling	automatic connection setup to a specified IP address (FTP)
Internal storage	SD card
Compression standard	MJPEG, H.264
Resolution max.	704x576
Resolution	704x576 (4CIF), 704x288 (2CIF), 352x288 (CIF)
Image transmission rate max.	25 B./Sek.
Frame rate	25 / 24 /15 / 5 Fps.
Image display	via Web Browser or Viewer Software
Ethernet interface	10Base-T, 100Base-TX
Web browser	MS Internet Explorer Vers. 6.0
Network protocols	TCP/IP (IPv4), ICMP, SMTP, DDNS, HTTP, DNS, FTP, DHCP, PPPoE, ICMP
Remote configuration	via web browser, remote software
Lens mount	CS mount
Digital zoom	no
Iris control	manual, DC
e-PTZ support	yes
Serial interfaces	RS-485, RS-232
Firmware update	SD card / USB / FTP
Password protection	3 password levels
Password protection	yes
Management Software Support	Aimetis - Symphony, Zelaris, Netavis, GL-Manager, Milestone XProtect Corporate
ONVIF	no
Camera mount	1/4" - 20 UNC thread on bottom
Power consumption	4.0W
Temperature range (operation)	0°C ~ +50°C
Colour	Pantone 400U
Supply voltage	12VDC
Power over Ethernet	no
Certificates	CE







Specifications (continued)

Parts supplied	Viewer Software, Power supply 100~240VAC/50Hz, USB connection cable, Manual
Weight	360g
Dimensions (HxWxD)	see drawing



Optional Accessories

Image	Artikel-Nr. / Typ	Description
	WD-23	Wall Mount Bracket with Ball Joint, 1/4" Camera Fixing Screw, Pantone 877
	WD-22	Wall Mount Bracket with Ball Joint, 1/4" Camera Fixing Screw, Beige Grey
	ZELARIS V08	Digital Video Network Crosslink, 8 Inputs, not Extentable, USB 2.0 Dongle
	ZELARIS V16	Digital Video Network Crosslink, 16 Inputs, not Extentable, USB 2.0 Dongle
	ZELARIS_IP VC	Client Version for Zelarip_IP Server for one Workstation
		Video Management Software for Standalone Systems, Basic Version, 4 Cameras

Optional Accessories (continued)

Image	Artikel-Nr. / Typ	Description
	ZELARIS_IP S04E	Server/Client Video Management Software Basic Version, 4 Camera Server license
	ZELARIS_IP S04E	Software Extension for Zelaris_IP S04 for further 4 Cameras, max. 64 Cameras
		Extension for Control Room Client for further up to 1024 Channels max.
		Control Room Client Software, Basic Version, Up to max. 1024 Channels
	F03Z2.710DC-NFS	F1.0/3-8mm DC Lens/var. Focal Length with No Focus Shift, 1/3" CS Mount
	F03Z2.6DC-NFSHR	F1.0/3-8mm DC Lens, Varifocal, No Focus Shift, High Resolution, 1/3" CS Mount
	YV5X2.7R4B-SA2L	F1.3/2.7-13.5mm DC Varifocal Lens, No Focus Shift, 1/3" CS Mount

Optional Accessories (continued)

Image	Artikel-Nr. / Typ	Description
	G04Z03NDDC-NFS	F1.2/4.5-12.5mm DC Lens/variable Focal Length, No Focus Shift, 1/2" CS Mount
	F07Z07NDDC-NFS	F1.3/7.5-50mm DC Lens/var. Focal Length with No Focus Shift, 1/3" CS Mount
	A10Z04NDDC-NFS	F1.4/10-40mm DC Lens/var. Focal Length with No Focus Shift, 1/2" C Mount

Technical Drawing

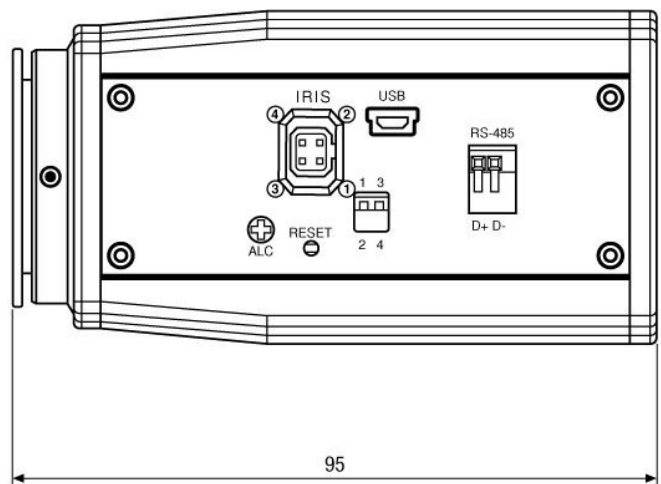
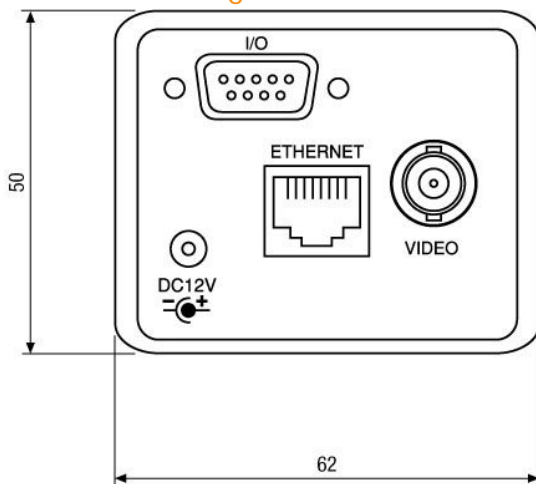

Maße/Dimensions: mm



Your partner for eneo products:

