



GLC-1610H

Article-No.: 92546

1/3" Network Day&Night Camera,
H.264, MJPEG, 520TVL, 720x576,
PoE, 12VDC/24VAC

Mainfeatures

1/3" Super HAD Colour/B&W CCD Sensor
Simultaneous Video Streaming (H.264 & MJPEG)
E-Mail and FTP Transmission of Important Events
Ethernet Interface: 10/100Base-TX
Equips two-way Audio with Built-in Microphone
SD Socket for Local Video Storage by SD Cards

Removable IR Cut Filter
Supports up to 25 ips. (PAL) in all Resolutions
Integral Activity Detection / External Alarm Input
DHCP or Static IP Switch Selection
Basic Setting via USB Interface and Network
Power Input via Power over Ethernet & 12VDC/24VAC

Specifications

| | |
|------------------------------------|--|
| Series | eneo GL |
| Resolution standard | SD |
| System | day&night |
| Video standard | PAL |
| Sensor size | 1/3" |
| Imager | CCD |
| Imager | Sony Super HAD Interline Transfer CCD (with HQ1 DSP) |
| Sensitivity (at 50% video signal) | 1,2 Lux |
| Sensitivity (at 50% video signal) | at F1.2 (measured) |
| Horizontal resolution | 520 TVL |
| Automatic gain control (AGC) | supplied |
| Automatic electronic shutter (ESC) | 1/50 - 1/100,000sec. |
| Digital Noise Reduction (DNR) | no |
| Low speed shutter | no |
| White balance | automatic/manually |
| Wide Dynamic Range (WDR) | no |



Specifications (continued)

| | |
|------------------------------|---|
| Backlight compensation | BLC |
| Backlight compensation | center weighted, fixed gain, disable |
| Flickerless function | yes |
| IR cut filter | switchable |
| Mirror function | supplied |
| Privacy zones masking | 3 areas |
| Activity detection | yes |
| Motion detector | 96 areas, 5 levels |
| Text display | supplied |
| Picture adjustments | Gain (AGC), Contrast, Brightness, BLC, AWB, Sharpness, Colour saturation, Flickerless |
| External adjustments | 2 DIP switches for: AES/DC iris, DHCP/Static IP, Reset, Flange focus |
| External connections | Video (BNC), USB 2.0, DC/AC jack connector, 12 pin terminal block (audio and alarm in/out, RS-485, DC out), 4 pin DC Iris control, SD card slot |
| Video outputs | composite (CVBS) |
| Video outputs | 1Vp-p, (C)VBS, 75ohms, BNC |
| Audio support | yes |
| Audio | built-in Microphone or Line-in 1Vp-p |
| Alarm inputs | yes |
| Alarm inputs | 1 (software supported) |
| Alarm outputs | 1x open collector |
| Alarm handling | per email, FTP, SD card, alarm out, ANNP |
| Internal storage | SD card |
| Compression standard | MJPEG, H.264 |
| Resolution max. | 720x576 |
| Resolution | 720x576 (Full D1), 352x288 (CIF) |
| Image transmission rate max. | 25 B./Sek. |
| Image display | via Web Browser or Viewer Software |
| Ethernet interface | 10Base-T, 100Base-TX |
| Web browser | MS Internet Explorer Vers. 6.0 |
| Network protocols | TCP/IP, UDP, HTTP, DHCP, UPnP, ARP, DNS, DynDNS, SNMP, PPPoE, SMTP, FTP, ICMP |
| Remote configuration | via web browser, remote software |
| Lens mount | CS mount |
| Digital zoom | no |
| Iris control | manual, DC |
| e-PTZ support | yes |
| Serial interfaces | RS-485 |
| Serial interfaces | Protocol: Pelco D |
| Firmware update | SD card / USB / FTP |
| Password protection | 3 password levels |
| Password protection | yes |
| Management Software Support | Aimetis - Symphony, Zelaris, Netavis, GL-Manager, Milestone XProtect Corporate |
| ONVIF | no |
| Camera mount | 1/4" - 20 UNC thread on bottom |







Specifications (continued)

| | |
|-------------------------------|---|
| Power consumption | 3.6W |
| Temperature range (operation) | 0°C ~ +45°C |
| Colour | Pantone 400U |
| Supply voltage | 12VDC, 24VAC, PoE (IEEE-802.3af) |
| Power over Ethernet | yes |
| Power over Ethernet | IEEE 802.3af |
| Certificates | CE |
| Parts supplied | Viewer Software, Power supply 100~240VAC/50Hz, USB connection cable, Manual |
| Weight | 410g |
| Dimensions (HxWxD) | see drawing |





Optional Accessories

| Image | Artikel-Nr. / Typ | Description |
|---|-------------------|--|
|  | WD-23 | Wall Mount Bracket with Ball Joint, 1/4" Camera Fixing Screw, Pantone 877 |
|  | WD-22 | Wall Mount Bracket with Ball Joint, 1/4" Camera Fixing Screw, Beige Grey |
|  | ZELARIS V08 | Digital Video Network Crosslink, 8 Inputs, not Extentable, USB 2.0 Dongle |
|  | ZELARIS V16 | Digital Video Network Crosslink, 16 Inputs, not Extentable, USB 2.0 Dongle |
|  | ZELARIS_IP VC | Client Version for Zelarip_IP Server for one Workstation |

Optional Accessories (continued)

| Image | Artikel-Nr. / Typ | Description |
|---|-------------------|--|
|  | | Video Management Software for Standalone Systems, Basic Version, 4 Cameras |
|  | | Server/Client Video Management Software Basic Version, 4 Camera Server license |
|  | ZELARIS_IP S04E | Software Extension for Zelaris_IP S04 for further 4 Cameras, max. 64 Cameras |
|  | | Extension for Control Room Client for further up to 1024 Channels max. |
|  | | Control Room Client Software, Basic Version, Up to max. 1024 Channels |
|  | F03Z2.710DC-NFS | F1.0/3-8mm DC Lens/var. Focal Length with No Focus Shift, 1/3" CS Mount |
|  | F03Z2.6DC-NFSHR | F1.0/3-8mm DC Lens, Varifocal, No Focus Shift, High Resolution, 1/3" CS Mount |

Optional Accessories (continued)

| Image | Artikel-Nr. / Typ | Description |
|---|-------------------|--|
|  | G04Z03NDDC-NFS | F1.2/4.5-12.5mm DC Lens/variable Focal Length, No Focus Shift, 1/2" CS Mount |
|  | YV5X2.7R4B-SA2L | F1.3/2.7-13.5mm DC Varifocal Lens, No Focus Shift, 1/3" CS Mount |
|  | F07Z07NDDC-NFS | F1.3/7.5-50mm DC Lens/var. Focal Length with No Focus Shift, 1/3" CS Mount |
|  | A10Z04NDDC-NFS | F1.4/10-40mm DC Lens/var. Focal Length with No Focus Shift, 1/2" C Mount |

Technical Drawing

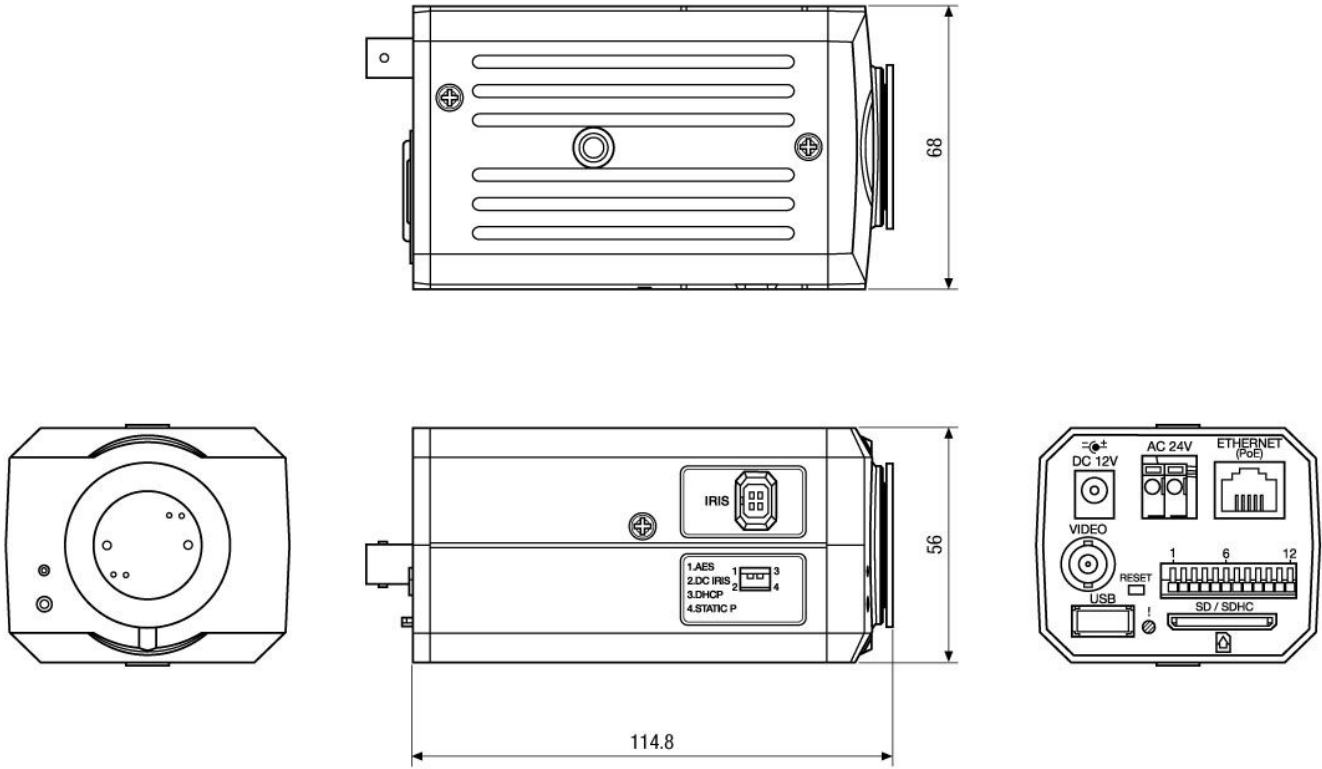

Maße/Dimensions: mm

Your partner for eneo products:

