



NTC-4101

Article-No.: 93153

1/4" Network Day&Night Camera,
22x, 720x576, 12VDC

Mainfeatures

1/4" Super HAD Colour/B&W CCD Sensor
Sensitivity of 0.45Lux at F1.2 (Colour)
High and Low Speed Shutter Control (MES/ESC/DSS)
Enhanced Dynamic Range (WDR/EDR)
Viewer for Monitoring, Recording and Configuration
Integrated Web Server: 10Base-T/100Base-TX

Integral 22x AF Zoom Lens / 11x Digital Zoom
Digital Noise Reduction (DNR)
On-screen Menu Control / Camera Title Display
Image Frame Rate: Up to 25 Fr./Sec. (720x576 Px.)
Pre and Post Event Recording (in Client PC)
E-mail Notification in Case of an Alarm

Specifications

| | |
|------------------------------------|--------------------------------------------------------------------------------------------------------------------------|
| Series | eneo NT |
| System | day&night |
| Video standard | CCIR/PAL |
| Sensor size | 1/4" |
| Imager | CCD |
| Imager | 1/4" Sony Super HAD Interline Transfer CCD |
| Signal processing | Digital (DSP) |
| Sensitivity (at 50% video signal) | 0.45Lux (colour); 0.24Lux (B&W). With 8x Low Speed Shutter, colour: 0.05Lux, b&w: 0.03Lux. Related to aperture F1.2 each |
| Horizontal resolution | 480 TVL |
| Automatic gain control (AGC) | 30dB max., ON/OFF switchable |
| Automatic electronic shutter (ESC) | 1/50 - 1/10,000sec., automatic and manual |
| Digital Noise Reduction (DNR) | yes |
| Low speed shutter | yes |
| Low speed shutter | 1/30sec. ~ 1sec. (to 2, 4, 8, 16, 32 and 60 Fps. selectable) |



Specifications (continued)

| | |
|-------------------------------|-----------------------------------------------------------------------------------------------------------------------------------------------------------|
| White balance | automatic (AWB) selectable for indoor and outdoor, or manual. |
| Backlight compensation | Wide range auto mode (WAWB, 1800-10500K) |
| Wide Dynamic Range (WDR) | BLC |
| Backlight compensation | no |
| IR cut filter | ON/OFF switchable with adjustable field size |
| Activity detection | switchable |
| Text display | yes |
| Picture adjustments | title, camera ID and status |
| OSD function control | Color, Brightness, Contrast (via Network) |
| External adjustments | D&N, AGC, BLC, AWB, Iris, MOD, PIP, Freeze, Digital zoom, Digital noise reduction (DNR) ON/OFF. Mirror, Enhanced Dynamic Range (WDR/EDR) and Shutter mode |
| External connections | Menu: ON/OFF Focus near/far Lens T/W LL phase (for AC models only) |
| Video outputs | video (BNC), power input, serial interface socket |
| Video outputs | composite (CVBS) |
| Audio support | 1Vp-p, (C)VBS, 75ohms, BNC |
| Alarm inputs | no |
| Alarm processing | no |
| Internal storage | built-in motion detection, adjustable sensitivity and dwell time, e-mail function |
| Compression standard | yes |
| Compression standard | MPEG-4 |
| Resolution max. | part 2 (ISO/IEC 14496-2), Profile: SP and ASP |
| Resolution | 720x576 |
| Image transmission rate max. | Network: 720x576 (D1), 640x480, 320x240, 160x120 Px. |
| Frame rate | 25 B./Sek. |
| Image display | 25fps @ 720x576 Px. (PAL) |
| Ethernet interface | via Web Browser or Viewer Software |
| Web browser | 10Base-T, 100Base-TX |
| Network protocols | MS Internet Explorer Vers. 6.0 |
| Bandwidth | TCP/IP, DHCP, HTTP, DNS, UDP, RTP, RTSP, SMTP, FTP |
| Lens type | adjustable |
| Lens | zoom |
| Lens mount | F1.6 / 3.9 - 85.8mm |
| Focal length | integrated lens |
| Digital zoom | 3,9 mm - 85,8 mm |
| Horizontal angle of view | 11x |
| Iris control | 50° - 2,46° |
| Iris control | DC |
| MOD (Minimum object distance) | auto-iris, with manual override |
| MOD (Minimum Object Distance) | 0,1-1 m |
| Filter screw size | Wide angle (x1 to x4): 10cm Tele end (x5 to x22): 1.0m. |
| Pre-alarm recording | Adjustable to 0.1m, 1.0mm, 1.5m, 2.5m and 6m |
| Post-alarm recording | M37x0.7mm |
| Search function | 180sec. max. |
| | up to 180sec. |
| | alarm/event/time searching |



Specifications (continued)

| | |
|-------------------------------|---------------------------------------------------------------------------------------------------------------|
| Serial interfaces | RS-232, RS-485 |
| Serial interfaces | Protocols: eneo Fastrax IIE and Pelco D&P |
| Remote configuration | via web browser, remote software |
| Access | 10 users simultaneous support |
| Firmware update | via network Interface, incl. viewer setup |
| Password protection | yes |
| e-PTZ support | yes |
| Camera mount | Mounting socket with 1/4" - 20 UNC thread. Assembling on bottom or top |
| Supply voltage | 12VDC |
| Power over Ethernet | no |
| Power consumption | 8W |
| Temperature range (operation) | 0°C ~ +35°C |
| Humidity range | 0 ~ 96% non-condensing |
| Colour | Beige with gray covers |
| Housing material | aluminium |
| Management Software Support | NT-Manager, Zelaris, Aimetis - Symphony, Netavis |
| ONVIF | no |
| Dimensions (HxWxD) | see drawing |
| Weight | 335g |
| Parts supplied | Viewer software with recording capability, Configuration and client CD-R, 12-pin adapter cable with open ends |
| Certificates | CE |

Optional Accessories

| Image | Artikel-Nr. / Typ | Description |
|-------------------------------------------------------------------------------------|-------------------|-----------------------------------------------------------------|
|  | EDC-KBD1 | System Keyboard with 3-axis Joystick, 12VDC |
|  | EDC-KBDM-3 | System Keyboard w. Joystick, 5" Monitor 12VDC, Fastrax Protocol |
|  | VKCD-1410/KB | Remote Controller for VKCD-1410, VKC-1416(A/B) and NTC-4101 |

Optional Accessories (continued)

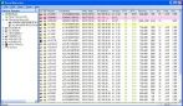
| Image | Artikel-Nr. / Typ | Description |
|-------------------------------------------------------------------------------------|-------------------|-----------------------------------------------------------------------------|
|  | KBD-2 | System Keyboard with 3-Axis Joystick and Jog Shuttle, 12VDC |
|  | FASTRAX_CONFIG | Configuration Software for Eneo Fastrax, Minitrax Dome Cameras and VKC-1416 |
|  | VT-PS12DC-7 | Plugable PSU w. Cont. & UK Mains plug-in 100-240VAC/12VDC-1.25A, Regulated |
|  | VT-PS12DCDT1 | PSU 12VDC/1.0A, Regulated, Desktop Version, 1.8m Cables each w. open ends |
|  | NT-MANAGER | Remote Administration Interface Software for eneo NW Series NT, NX, NL |
|  | NT-SMARTMANAGER | Utility S/W Tool for eneo Network Series NT, NX, NL |

Technical Drawing

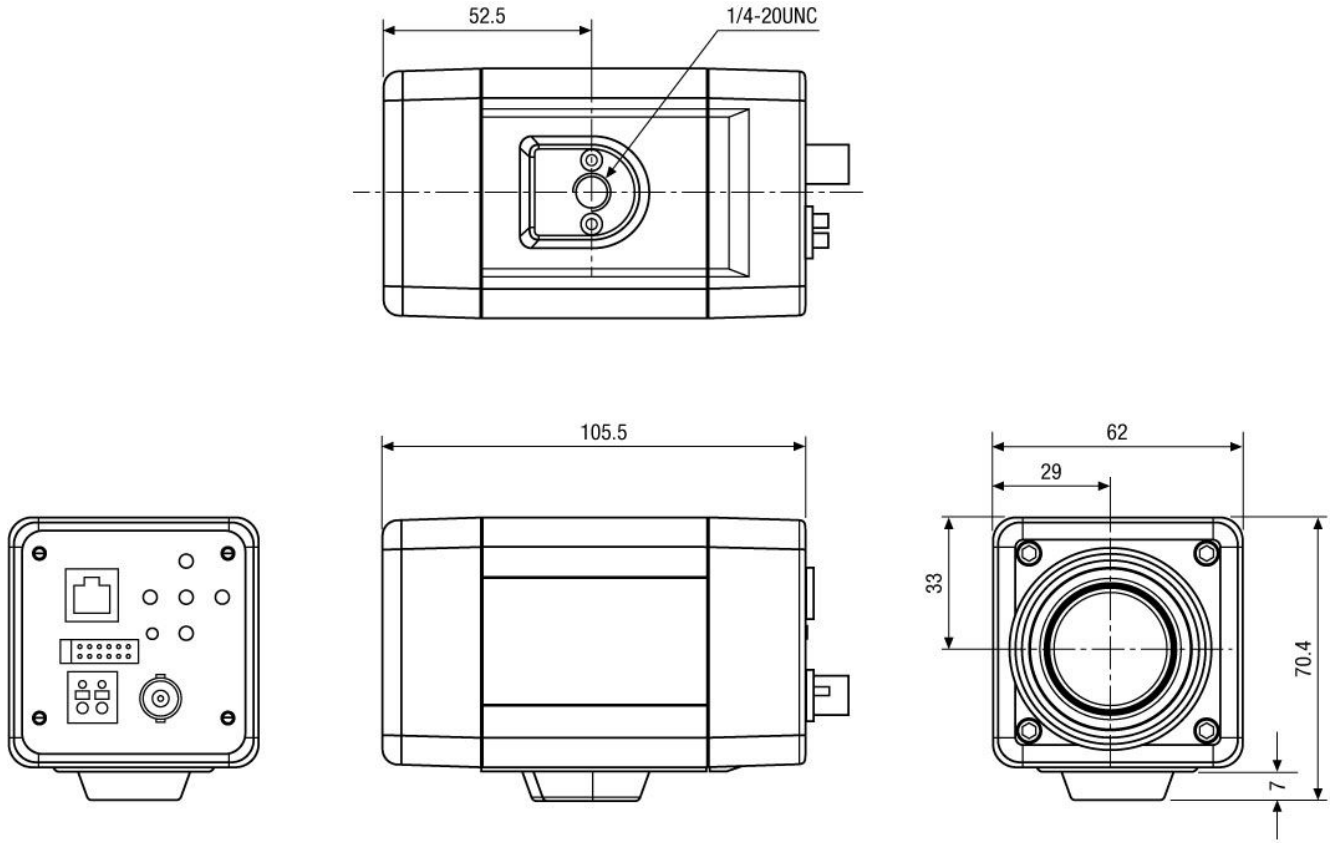

Maße/Dimensions: mm

Your partner for eneo products:

