

**Instruction Manual**

**Hidden CCD Camera VK-1321/PIR (B&W),  
VKC-1338/PIR (Colour)**



# Contents

1.	Safety Instructions .....	3
2.	Description .....	4
3.	Installation .....	5
4.	Wiring Instructions .....	6
5.	PIR Detector Board Installation and Descriptions .....	7
6.	Specifications .....	10
7.	Dimensional Drawings .....	12

# 1. Safety Instructions

- Read these safety instructions and the operation manual first before you install and commission the camera.
- Keep the manual in a safe place for later reference.
- Protect your camera from contamination with water and humidity to prevent it from permanent damage. Never switch the camera on when it gets wet. Have it checked at an authorized service center in this case.
- Never operate the camera outside of the specifications as this may prevent the camera functioning.
- Do not operate the cameras beyond their specified temperature, humidity or power ratings. Operate the camera only at a temperature range of -10°C to +50°C and at a humidity of max. 90%.
- To disconnect the power cord of the unit, pull it out by the plug. Never pull the cord itself.
- Pay attention when laying the connection cable and observe that the cable is not subject to heavy loads, kinks, or damage and no moisture can get in.
- The warranty becomes void if repairs are undertaken by unauthorized persons. Do not open the camera housing.
- Never point the camera towards the sun with the aperture open. This can destroy the sensor.
- Installation, maintenance and repair have to be carried out only by authorized service centers. Before opening the cover disconnect the unit from mains input.
- The fitter is responsible for the system of protection being followed in accordance with the technical data, e.g. by sealing of the cable outlet with silicone.
- Contact your local dealer in case of malfunction.
- Only use original parts and original accessories from Videor E. Hartig GmbH.
- Do not use strong or abrasive detergents when cleaning the housing. Use a dry cloth to clean the dome surface. In case the dirt is hard to remove, use a mild detergent and wipe gently.

**NOTE: This is a class A digital device. This digital device can cause harmful interference in a residential area; in this case the user may be required to take appropriate corrective action at his/her own expense.**

## 2. Description

This B/W (Colour) HIDDEN CCD Camera uses high sensitive 1/3" interline transfer CCD Image Sensor (CCD = Charge Coupled Device), and all state circuitry which provides extremely long life and high reliability.

This Camera offers excellent image quality with low lag and high burn resistance, and is not subject to distortions from magnetic fields.

Highly resistance to shock and vibration, and easy to install this Camera is a very good choice for your B/W (Colour) CCTV system.

- For Wall Mount
- Resolution of 600 Horizontal Lines (**VK-1321/PIR, # 91989**)  
Resolution of 470 Horizontal Lines (**VKC-1338/PIR, # 91991**)
- Built-in Pinhole Lens F2.0/3.7mm
- Electronic Shutter Control (ESC) (**VK-1321/PIR, # 91989**)  
Automatic Shutter Control (AES) (**VKC-1338/PIR, # 91991**)
- Automatic Gain Control (AGC)
- Automatic White Balance (AWB) (**VKC-1338/PIR, # 91991**)
- Internal Synchronization
- PIR Sensor Function
- Supply Voltage: 12VDC
- Easy installation

### 3. Installation

1. Secure the bracket to the wall with screws (included).

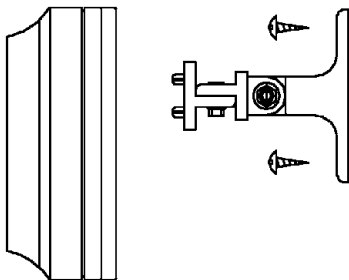

2. Attach the Camera Case to the bracket.

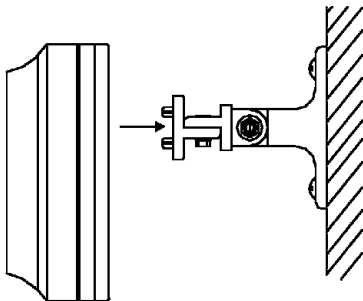

- Adjust the vertical and horizontal angles by loosening screws (A&B) and by turning the bracket vertically and horizontally.

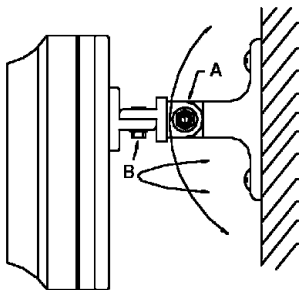

#### 4. Wiring Instructions

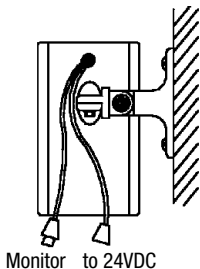

- Connect the coaxial cable between the camera and the monitor using a 75ohms coaxial cable.
- Insert the AC plug into the AC power socket and the DC plug to the DC Jack.



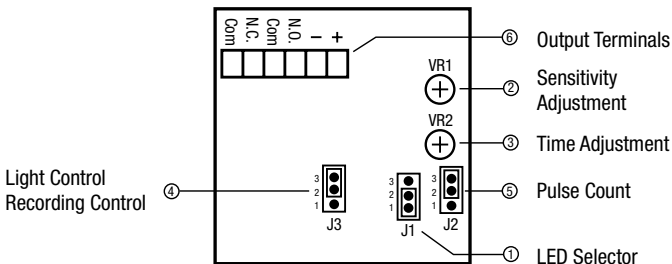

**Note: AC Adapter Sold separately (see Accessories)**

## 5. PIR Detector Board Installation and Descriptions

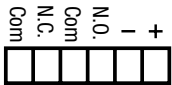

Options	Description
1. LED Selector  J1 (3 pins: Top, Center, Bottom)	A. Top + Center w/black cap: Upon walk-testing: Light blinking (disadvantages: Easy to identify as a security system.) B. Center + Low w/black cap: No light blinking while detecting. (advantages: less obvious)
2. Sensitivity Adjustment  „VR1”	A. To raise sensitivity: Turn clockwise to detect longer distance and wider pattern. B. To lower sensitivity: Turn counter clockwise for detection in narrow areas.
3. Dwell Time Adjustment  „VR2” Adjustable from 2 to 40sec.	For closure period of N.C/N.O relay connected to an alarm panel, light control or recording control of time lapse VCR, etc. A. Max. time: Turn counter clockwise B. Min. time: Turn clockwise Top + Center pins of „J3” must be selected to adjust the time setting.

Options	Description
<p>4. Alarm control, Light control or Recording control (N.O or N.C)</p>  <p>J3</p> <p>(3 pins: Top, Center, Bottom)</p>	<p>A. Top + Center w/black cap: Operate with „VR2” to adjust time. (To set the relay output of the Light control or Recording control, the time is selected by individual preference or application.</p> <p>B. Center + Bottom w/black jumper: Relay output can be set for Security control panel for only 2 seconds.</p> <p><b>Note: N.C./N.O. relay output current: 1A 125VAC, 2A 30VDC.</b></p>
<p>5. Pulse Control Once or twice</p>  <p>J2</p>	<p>A Set to „ONCE” for instant reaction when PIR detects someone: and either the „alarm or Security control panel” or „Recording control” will be triggered immediately.</p> <p>B Set to „Twice” when PIR detects someone 2 times within 15 seconds.</p>
<p>6. Output Terminals</p>  <p>24 Hour/Anti-Tamper</p>	<p>N.C.: Normally Closed</p> <p>A. For connection to: Security panel or Light control CCTV ...etc.</p> <p>B. With anti-tamper function for 24 hours.</p> <p>N.O.: Normally Open Contacts</p> <p><b>Note: Relay output current: 1A 125VAC, 2A 30VDC</b></p>
<p>7. Power: 12VDC</p> <p>Standby Current: 3mA, Working Current: 28mA</p>	<p><b>Caution:</b></p> <p><b>The PIR is triggered by body movement, excluding fixed objects, however, do not place in direct sunlight or reflected sunlight.</b></p>

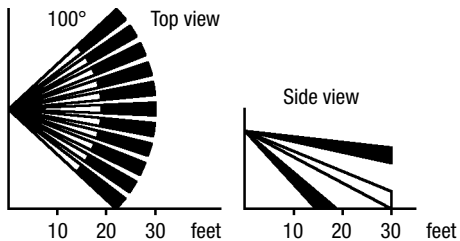

- Wide angle lens up to 100°, coverage areas to 30x30 feet
- Provide 64 beams in 3 layers

## 6. Specifications

Type	VK-1321/PIR	VK-1338/PIR
Art. No.	91989	91991
System	Black/white	Colour
Video standard	CCIR	PAL
Sensor size	1/3"	
Imager	CCD, Sony Super HAD Interline Transfer	
Synchronization	Internal	
Signal-to-noise ratio	48dB	
Gamma correction	0.45	
Horizontal resolution	600 TVL	470 TVL
Sensitivity (at 50% video signal)	0.23Lux at F1.2; 0.65Lux at F2.0 (Videor measurement result)	2.0Lux at F1.2 (Videor measurement result), 5.6Lux at F2.0
Autom. electron. shutter (ESC)	1/50 ~ 1/100,000sec.	
Low Speed Shutter	no	
Automatic gain control (AGC)	Supplied	
Digital Noise Reduction (DNR)	no	
White Balance	–	Automatic
Backlight compensation	no	
Wide Dynamic Range (WDR)	no	
IR cut filter	no	Standard
Video outputs	VBS	CVBS
Lens type	Fixed focal length	
Lens	F2.0/3.7mm Pinhole	
Aspherical technology	no	
Focal length	3.7 mm	
Horizontal angle of view	68°	
Iris control	no	
Filter screw size	Not available	
MOD (Min. object distance)	0.1 m	

<b>Illumination</b>	no	
<b>Serial interfaces</b>	no	
<b>External connections</b>	Video (BNC), 12VDC (DC plug)	
<b>Mounting</b>	Wall mount (bracket included)	
<b>Protection rating</b>	IP20	
<b>Supply voltage</b>	12VDC, (+/-10%)	
<b>Power consumption</b>	1.44W	2.5W
<b>Temperature range (operation)</b>	-10° ~ +50°C	
<b>Housing material</b>	Plastic	
<b>Housing</b>	Indoor	
<b>Integrated wall mount</b>	yes	
<b>Hidden cable management</b>	no	
<b>Sunshield</b>	no	
<b>Window heater</b>	no	
<b>Clear Shield</b>	no	
<b>Colour (housing)</b>	Light grey	
<b>Dimensions</b>	See drawing	
<b>Weight</b>	110g	125g
<b>Special features</b>	PIR sensor function. NO/NC relay contact output (125VAC/1A, 30VDC/2A resistive), Adjustable switching duration: 2~40sec. Sensor field angles: 100° horizontal/ 45° vertical. Detection range: up-to 10m	
<b>Certificates</b>	CE	

### Optional accessories

<b>Art. No.</b>	<b>Type</b>	<b>Description</b>
<b>70535</b>	<b>VT-PS12DC-8</b>	Plug-in Power Supply Unit 100-240VAC 12VDC (1.0Amp), regulated, with DC Plug
<b>77773</b>	<b>VT-PS12DCDT1</b>	PSU 12VDC/1.0A, regulated, desktop version, 1.8m cables each with open ends
<b>70495</b>	<b>VT-PS12DC-7</b>	Plugable PSU with Continent & UK Mains plug-in 100-240VAC/12VDC-1.25A, regulated

## 7. Dimensional Drawings

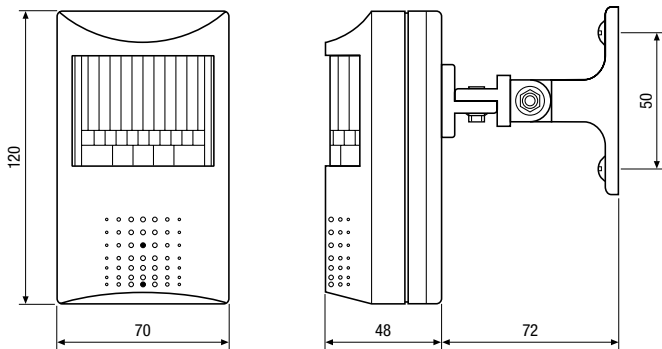

Dimensions: mm



eneo® is a registered trademark of Videor E. Hartig GmbH  
Exclusive distribution through specialised trade channels only.

Videor E. Hartig GmbH  
Carl-Zeiss-Straße 8 · 63322 Rödermark/Germany  
Tel. +49 (0) 6074 / 888-0 · Fax +49 (0) 6074 / 888-100

[www.videor.com](http://www.videor.com)



Technical changes reserved

© Copyright by Videor E. Hartig GmbH 02/2010